

# MONO SPIRAL PUMP

## JN-SLF TYPE

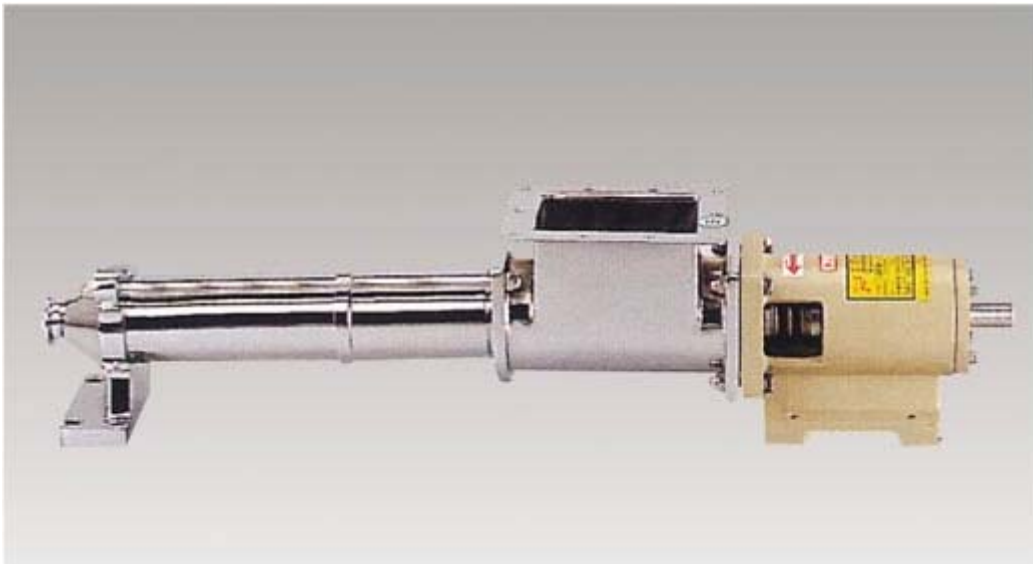

### **JIN NONG MACHINERY CO., LTD.**

No.2-1, Lane 49, Sec.3, Fusing Rd., Sinjhuang, Taipei 24251, Taiwan

TEL : 886-2-29923134      FAX : 886-2-29902946

<http://www.jin.com.tw>

e-mail: [jinnong@ms11.hinet.net](mailto:jinnong@ms11.hinet.net)

# Index

- ◎ Applications
- ◎ Theoretical Pump-Out
- ◎ Dimensions
- ◎ Features
- ◎ Structure
- ◎ Operating Principles
- ◎ Examples
- ◎ How to use
- ◎ Error Solution

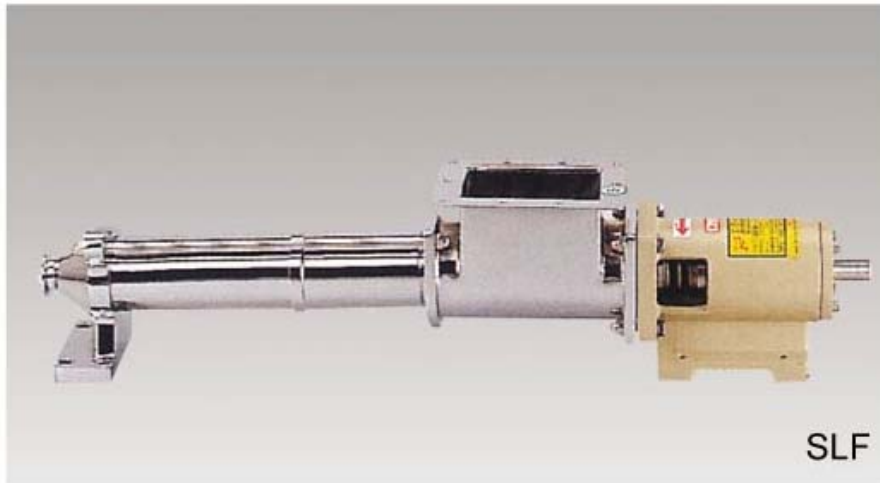

**Application:**

Medium viscosity, high viscosity, containing granules, in poor flowing ability liquid.

### Jin Nong Mono Spiral Pump Application

**FOOD STUFFS**

Jams, chocolate, syrups, sauces, tomato ketchup, batters, stews, sausage meats, eggs, fats, gelatin, soup, liquid sugar, molasses, honey, vinegar, preserves, soya sauce, peanut butter, jelly, chutney, mincemeat, olive oil, palm oil, chicken paste, coconut oil, cod oil, ketchup, maple syrup, marmalade, salad dressing, flavoring, pulp.

**DAIRY PRODUCTS**

Milk, curdled milk, yogurt, whey, cheese, curd, butter, margarine, oils, creams, cheese whey, mousse, custard cream cheese, pudding.

**Beverages**

Beer, wines, alcohol, syrups, yeast, wort, spirits, juices, cordials, minerals, tea, water, coffee liquor, cordials, cranberry juice.

**PAPER & CHEMICALS**

Acids, alkaline, soaps, paints, dyes, lacquers, resins, lubricants, solvents, black liquors, adhesives, latex, waxes, coatings, pastes, nail polish, mascara

**PHARMACEUTICALS**

Cream, gels, serums, disinfectants, lotions, shampoos, perfumes, soaps, toothpaste, vaccines, Vaseline, antibiotics, glucose, iodine ointment, perfumes.

### Theoretical Pump-Out

| Model                           | SLF-200 | SLF-300 | SLF-400 | SLF-500 |
|---------------------------------|---------|---------|---------|---------|
| Granularity<br>(mm)             | 10      | 15      | 18      | 22      |
| Theoretical pump-out<br>(cc/1R) | 115.4   | 423.6   | 666     | 1017.3  |

### JIN NONG MONO SPIRAL PUMP FEATURES

- \* To deliver semi-solid, low water containment, high density and high viscosity liquid.
- \* 3-sectional universal joint allows better flexibility.
- \* To deliver liquid containing air bubbles, granules, solids, and fibers.
- \* The flow volume could be widely controlled.
- \* With high pressure, with super self-sucking.
- \* Purging with water, easy disassembly for flushing.
- \* Cylinder type of shaft connection, free of risks of broken pins.
- \* Precision ceramic used for shaft seal.

# JN-SLF TYPE DIMENSIONS

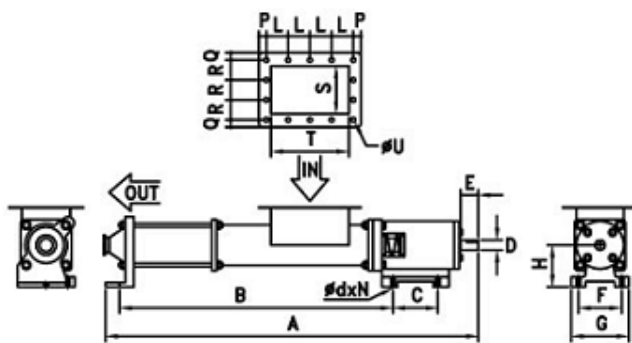
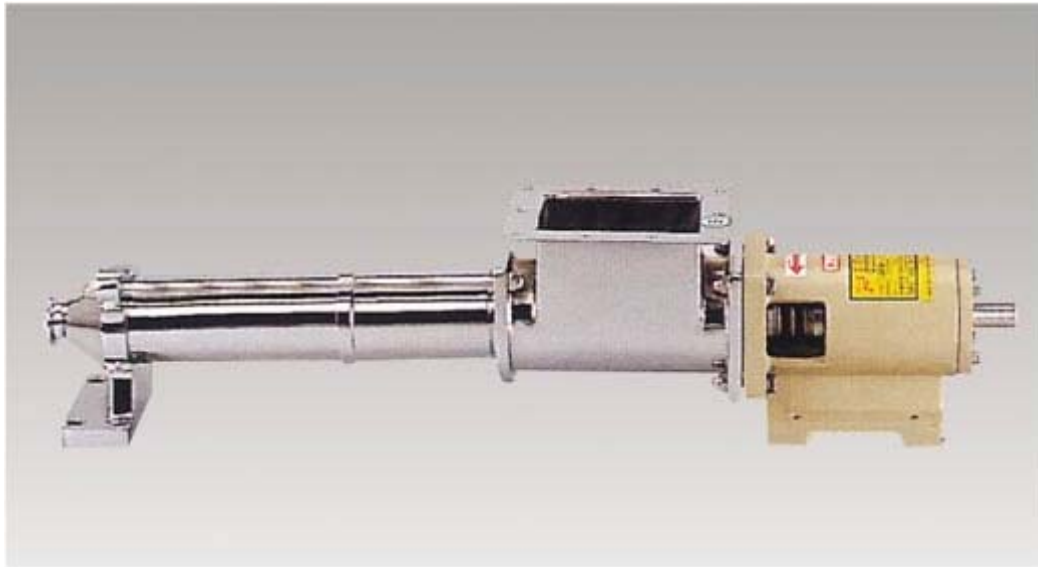

Unit: mm

| Model   | A    | B    | C   | D         | E  | F   | G   | H   | ØdxN | P      | L    | Q    | ØU | R    | T   | S   | KG  |
|---------|------|------|-----|-----------|----|-----|-----|-----|------|--------|------|------|----|------|-----|-----|-----|
| SLF-200 | 940  | 697  | 114 | Ø25 x W8  | 45 | 110 | 145 | 105 | 11x4 | 20.5x2 | 73x3 | 21x2 | 9  | 75x2 | 175 | 106 | 33  |
| SLF-300 | 1213 | 898  | 150 | Ø30 x W10 | 60 | 150 | 180 | 125 | 11x4 | 23x2   | 90x3 | 21x2 | 9  | 75x2 | 234 | 106 | 67  |
| SLF-400 | 1356 | 987  | 176 | Ø35 x W10 | 65 | 180 | 220 | 150 | 13x4 | 23x2   | 66x4 | 19x2 | 10 | 88x2 | 228 | 134 | 81  |
| SLF-500 | 1570 | 1168 | 196 | Ø40 x W12 | 75 | 220 | 260 | 160 | 13x4 | 23x2   | 70x5 | 22x2 | 10 | 94x2 | 305 | 146 | 108 |



# JIN NONG MONO SPIRAL PUMP FEATURES

## 1 Non-pulsating, fixed volume in conveyance.

MONO PUMP'S continuous fluid can do the job for non-pulse conveying with fixed volume what you desired.

( For Example )

- Intermittently operated with fixed volume fed.
- Can be combined with other machines by controlling volume and timer in process.
- In case of viscosity & concentration changed still can do fixed volume supply.



## 2 The flow volume could be widely controlled.

MONO PUMP'S ex volume with rotating speed are equal (by using shiftable motor).

(For Example )

- Feeding volume can be controlled by timer or speed controller,
- Can do at least 2 kinds of liquid compound especially in ship.

## 3 There are no turbine flow, turbulence, pulse and no harm for liquids.

(For Example )

It can convey a very sensitive latex and synthetic resin, the quality never get hurt.

- Can do the job for detaching oil and water.
- Margarine and candy juice will not be disconnected while conveying.
- There will be no re-pollution when conveying in the muddy ground.



## 4 With super self-sucking

MONO PUMP has the ability of high sucking power, even no stop valve or auxiliary equipments it has high sucking power for liquids.

( For Example )

- Can suck high-viscosity mud, dropping from a depth of 5-6 feet.



## 5 With high ex pressure.

No matter the liquid's density is high the MONO PUMP is able to generate high ex pressure.

( For Example )

- Can do as a spray gun for drier or burning stove.
- Can spray cement paste for high building's steel construction.
- Can spray cement paste or spray weeds at the mountain side for soil conservation use.



## 6 To do backward conveying it's efficiency remain unchanged.

It means end of the conveying action, inside the pipe still reserve some materials, and liquids backward flow's volume and pressure remain unchanged.

(For Example )

- If needed to return liquids inside the tube, just reverse the flow direction.



## 7 Semi-solid, low water containment, fluffy containing granulations, non-flowing substances.

( For Example )

- Conveying for the following liquids: chopped meat, meat paste, curry, fish, shells, fruit jam, vegetable paste, grapes, rice, pickled bean, unfiltered wine, dregs of coffee, juice, soy, long fiber pulp, mire with glass fiber, asbesto fiber and nylon piece electrical slaughter house as well.



## 8 Deodorizing.

- The dehydrated dregs of water purify plant are normally drained out stink, so using pipeline convey is more safe as stink will not drain out and protect the environment accordingly.

( For Example )

- To convey the scrap of construction projects.
- To convey the waste materials in the factory.



## 9 It's able to convey for various liquids.

Good for water and high-viscosity and high density materials. Even such as gum material is very sticky MONO PUMP can qualify the job.

( For Example )

- Cake's material, smashed fish, meat, mair sugar, cosmetic, adhesive, grease, resin ink, varnish, etc.



## 10 Can be freely combined with pipeline system in a smaller space.

- It's able to convey, absorb, feed for both small and large volume.
- Able to comply with any other automatized requirements.
- Noiseless.
- Easily maintained.
- Simple system. It's moveable depending on space.

## JIN NONG MONO PUMP INTERIOR WEAVE

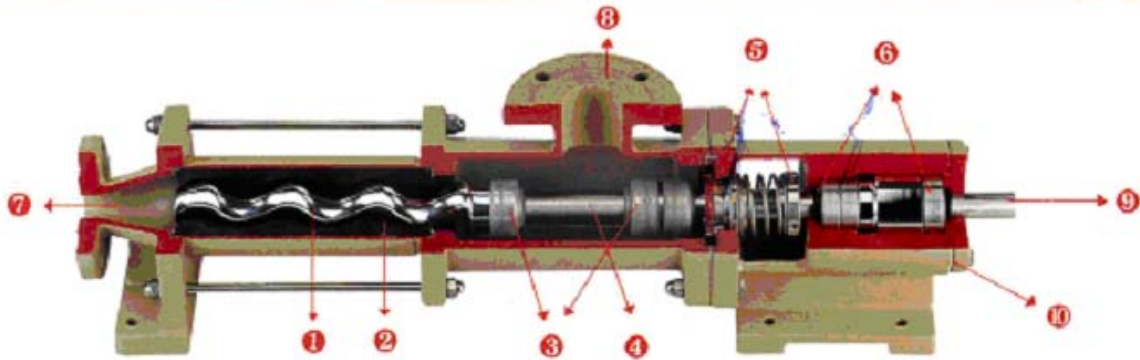

| No. | Name        | Materials            | No. | Name         | Materials      |
|-----|-------------|----------------------|-----|--------------|----------------|
| 1   | Rotor       | SUS #304             | 6   | Bearing      | SUJ2           |
| 2   | Stator      | SILICONE, VITON, NBR | 7   | Outlet       | SUS #304, FC20 |
| 3   | Connector   | SUS #304             | 8   | Inlet        | SUS #304, FC20 |
| 4   | Connect Rod | SUS #304             | 9   | Shafting     | SUS #304       |
| 5   | Sealing     | Precision Ceramic    | 10  | Bearing Seat | FC20           |

### Jin Nong Mono Pump Features

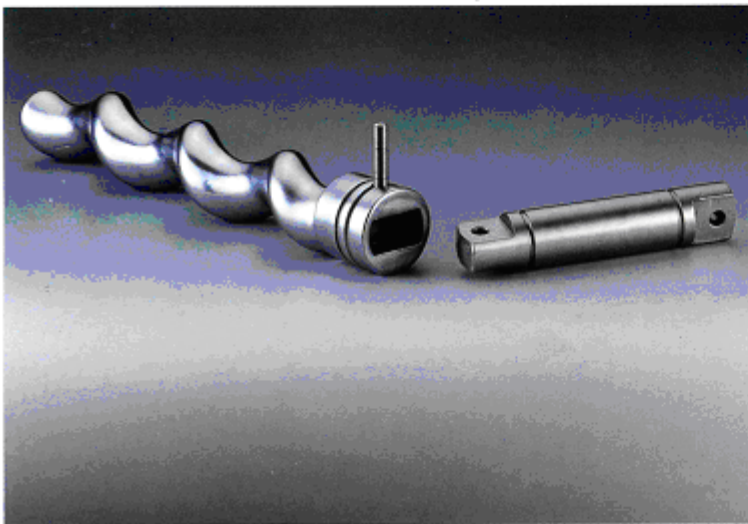

1. Taiwan  
Patent No: 105163, 111543, 119310.  
U.S.A. Patent No: 5562360  
Germany Patent No: 29605905.6
2. Cylinder type of shaft connection, free of risks of broken pins.
3. 3-sectional universal joint allow better flexibility.
4. Precision ceramic used for shaft seal.
5. Stainless steel material, allowing health rated.
6. Purging with water, easy disassembly for flushing.



## Detailed sketch for Fixed Unit

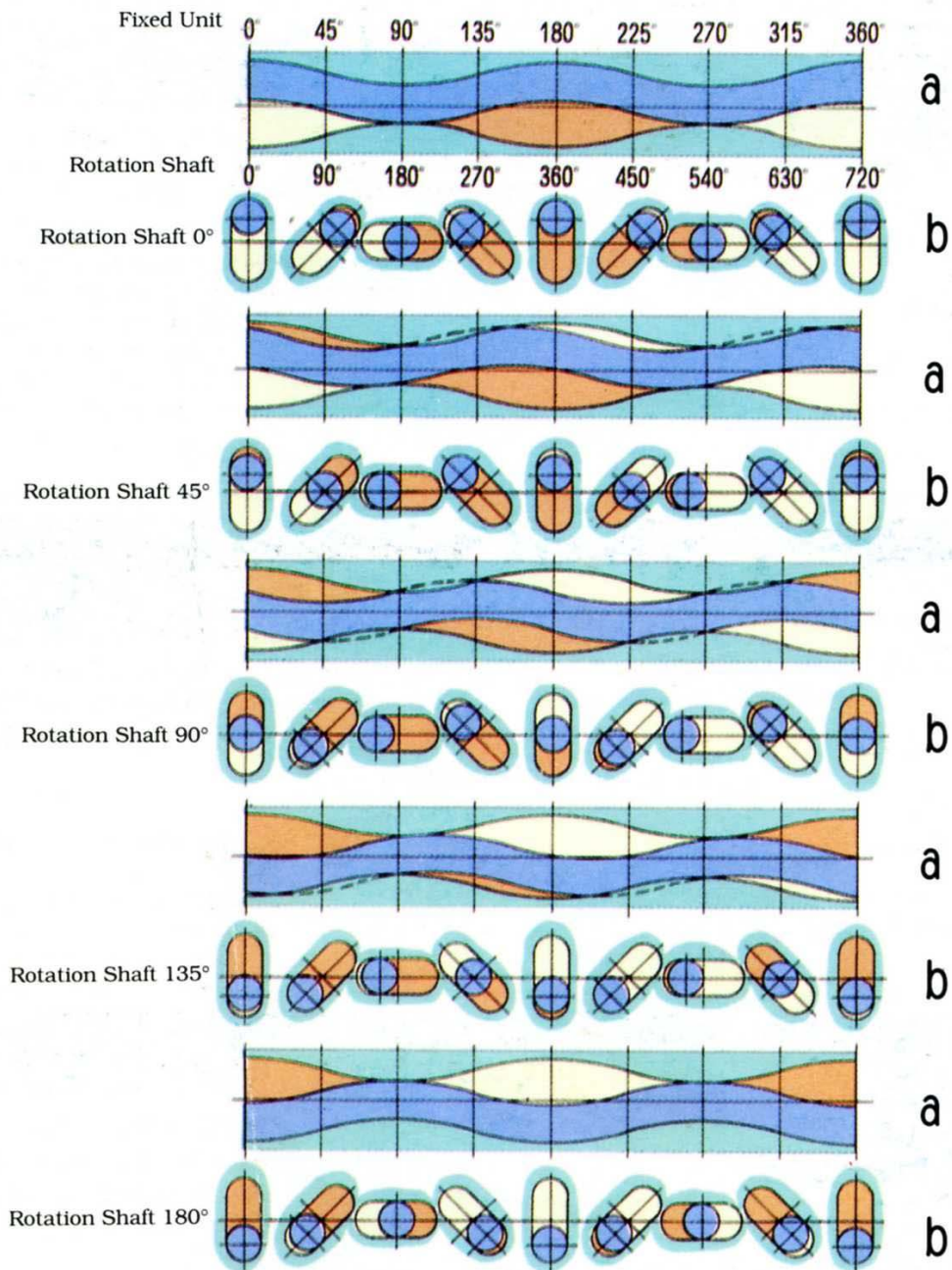



# JN-SLF TYPE EXAMPLES

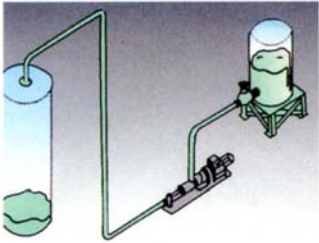

Conveying liquid into the larger capacity



Bean Paste Conveyed

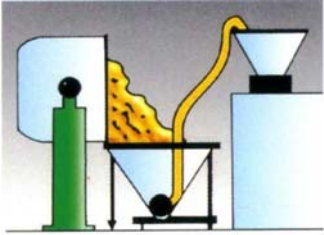

Conveying liquid from the capacity to the packing machine

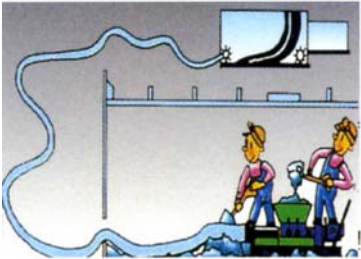

Conveying for muddy brick, sand pulp

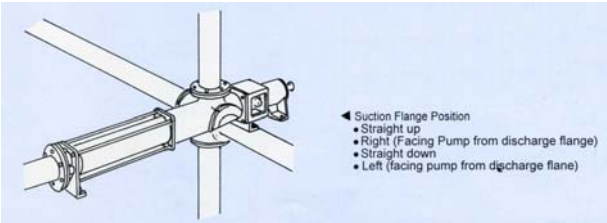
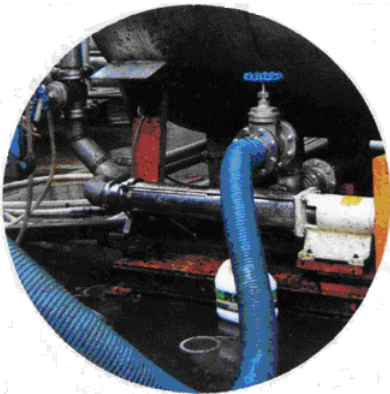

# JN-SLF TYPE EXAMPLES

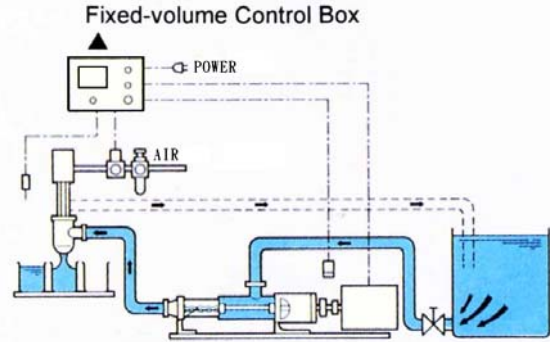
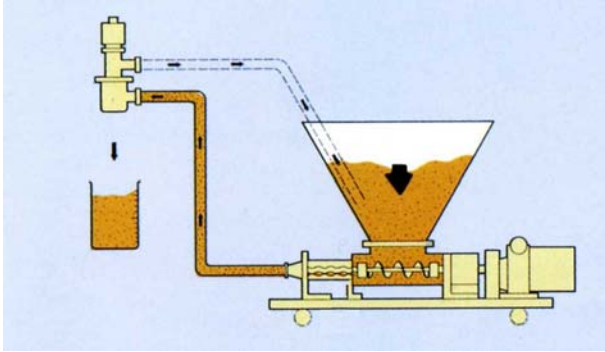

▲ Allowing direct pump from the storage tank for volumetric filling.

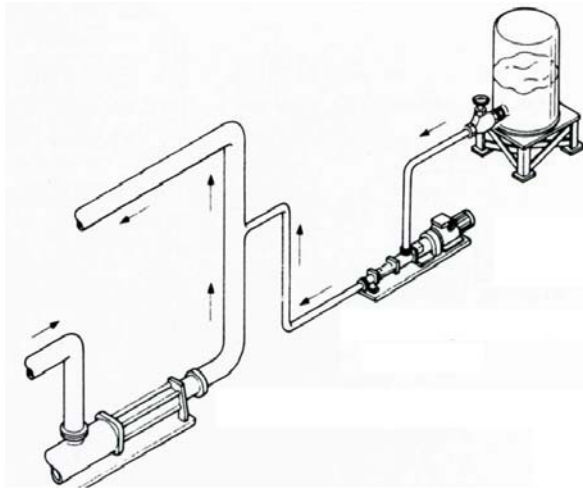

▲ Allowing dual-liquid application

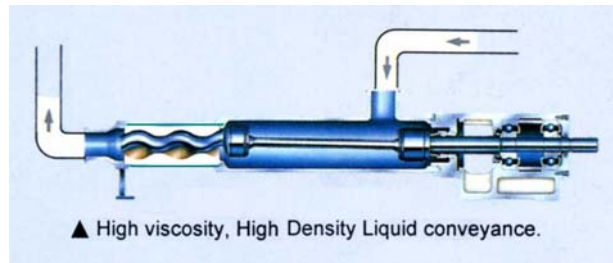

▲ High viscosity, High Density Liquid conveyance.

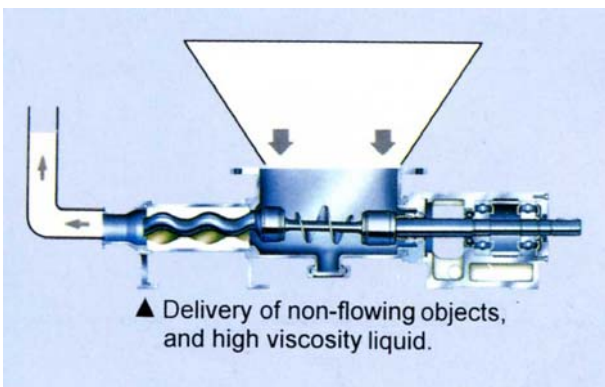

▲ Delivery of non-flowing objects, and high viscosity liquid.

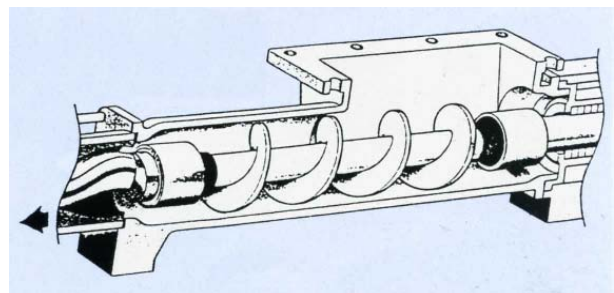

# HOW TO USE JIN NONG MONO SPIRAL PUMP ?

## A MAKE UP

- 1 Cleaning up the interior of the pipe from the tank to the mono spiral pump inlet.
- 2 Set the mono spiral pump on the base plate, so that the mono spiral pump can be used normally.
- 3 From the tank to the mono spiral pump inlet and the mono spiral pump outlet should be connected tightly.

## B START

1. Before starting the power, you should open the inlet and outlet.

## 2. UNLOAD ROTATION PROHIBITED.

3. It is hard to start to convey when you open the power at the first time.  
The stator and the rotor are new. You can wash the stator with water, that you can start the mono spiral pump easily.
4. After starting, should be pay attention that the turning is right.
5. When it is conveying, should be pay attention that the conveying liquid is full.

## C CLEAN

If you do not want to wash the mono spiral pump after using the mono spiral pump, you can fill the mono spiral pump with water, and then open the power. It will clean the interior itself.



## HOW TO SOLVE THE ERROR ?

- 1 Why the conveying amount is getting less and less ?
  - a. The stator and the rotor are damaged.
  - b. There is something at the inlet conveying pipe.
  - c. The viscosity liquid was dried in the packing case.
  - d. The conveying liquid is constructive above the packing case.
- 2 The conveying liquid is constructive :
  - a. Make the mixer to disturb the liquid.
  - b. Change the larger type, the inlet is bigger and the speed is more slowly.
- 3 The liquid is low flowing ability, high viscosity, low water containness, should use the big inlet mono pump.
- 4 Make a net above the inlet, so that the hard things will not be in the mono pump, and make the mono pump broken.
- 5 When it is conveying you can heard the water flowing :

It shows the liquid flowing speed is slower than the mono pump sucking speed.

  - a. Check the inlet there is something above it.
  - b. The density or the viscosity of the liquid is changed.
- 6 JN-TOA-100 type conveying amount is less and less or stop conveying :
  - a. The pump above the label, using for sucking or conveying :

the sealing, the rotor, and the stator are damaged.
  - b. The pump below the tank, using for conveying :

the rotor and the stator are damaged.
- 7 It shows the sealing is damaged :
  - a. Liquid is flowing from the sealing seat. ( JN-TOA-100 )
  - b. Liquid is flowing from the motor seat. ( JN-T , JN-TOA-100 )
- 8 Why the sealing can not work :

The pressure from the tank is higher than the mono pump can be suffered, discount the pressure from the tank.
- 9 Why the stator pipe is leaking liquid :

Take of the stator, put the gasket horizontal with the stator, then compose the mono pump and you can use it.

