

LEVER / PLATE MORTISE LOCKSETS

ETM

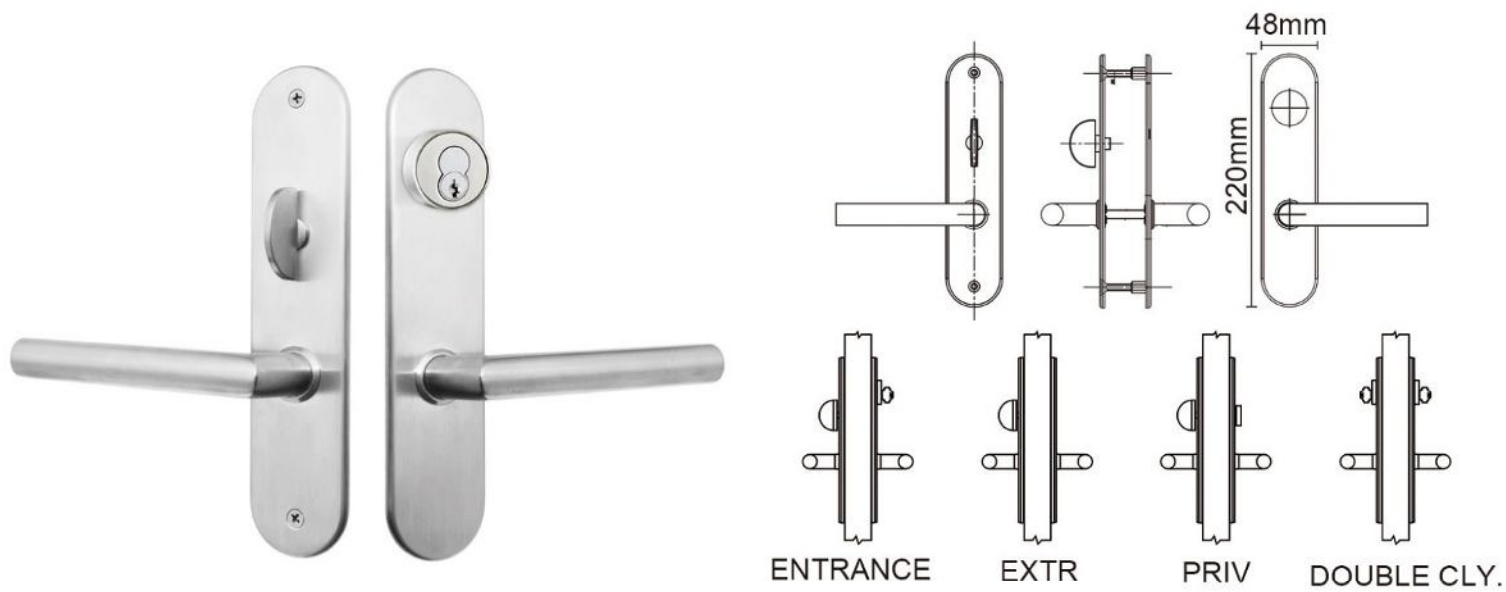

TCE

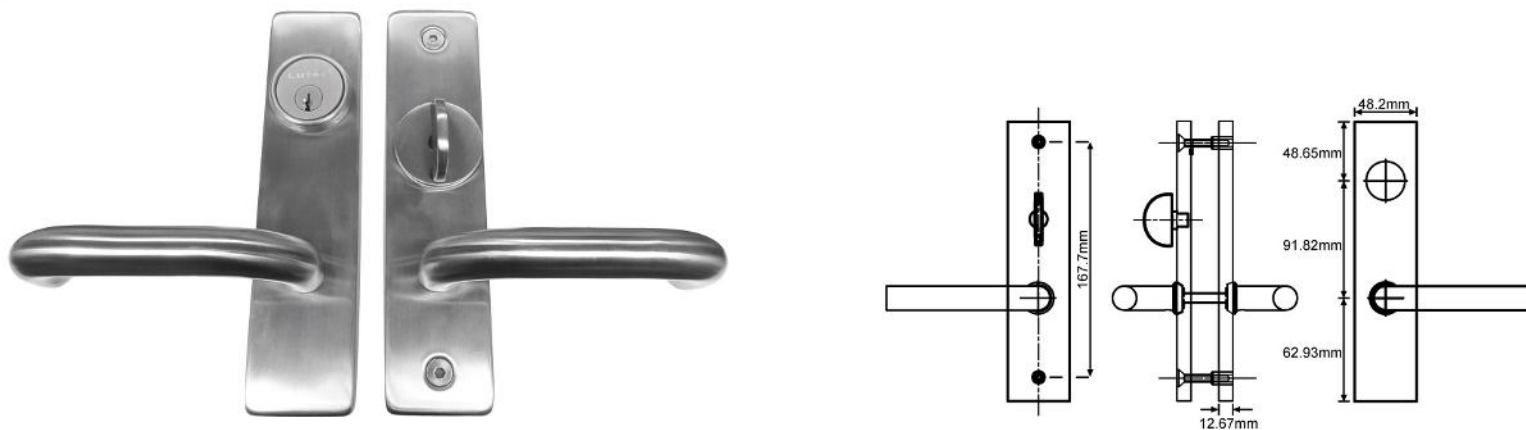

Lock Case

All bolts are made of stainless steel SUS304, most working parts inside the case are made of high strength steel alloy.
5.82"(147.7mm) x 4.15"(105.4mm) x 0.85"(21.6mm).

Front Plate

Stainless Steel SUS304/316 or Brass.
8"(203mm) x 1-1/4"(32mm) x 3/32"(2mm) standard.
8"(203mm) x 1-1/16"(27mm) x 3/32"(2mm) optional.

Latchbolt

3/4" (19mm) Throw, 2-piece mechanical with anti-friction, all Stainless steel.

Strike

4-7/8"(123.6mm) x 1-1/4"(31.5mm) ,Non-handed, Stainless steel.

Cylinder

Brass, 6-pin or 5- pin, with two nickel-silver keys. Schlage C keyway.

Door Range

1-3/4"(44mm) – standard.
1-1/2"(38mm) to 3"(76mm)

Backset

2-3/4"(70mm) only.

Deadbolt





1"(25mm) Throw, stainless steel

Auxiliary Latch

0.52"(13.2mm) ,Non-handed.

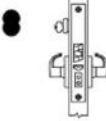
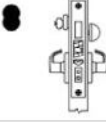
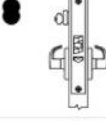
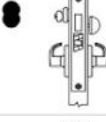
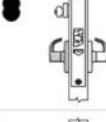
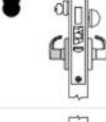
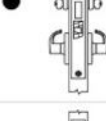
LEVER / PLATE MORTISE LOCKSETS

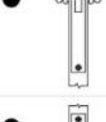
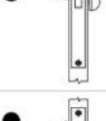
M800 Series Mortise Functions

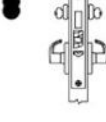
Model No.	ANSI No.	LOCATION	DIAGRAM INT EXT.	OPERATION
M810	F01	Passage Closet		Latch bolt operated by lever either side at all time.
M820	F04	Entry		Latch bolt operated by lever either side except when outside lever is made inoperative by push button rocker. When outside lever is lock, latch bolt may be retracted by key
M830	F12 F13	Entrance Department Office		Latch bolt operated by lever either side, unless outside lever is locked toggle-action stop or by projection of deadbolt. Deadbolt by key outside or by thumb turn inside.
M840	F05	Classroom		Latch bolt open by lever either side, unless outside lever is locked by key outside. Auxiliary latch deadlocks latch bolt. Inside lever always free.
M850	F13	Dormitory Exit		Latch bolt by lever either side, Deadbolt by key outside or by thumb turn lever inside. Inside lever simultaneously retracts latch bolt and deadbolt.
M860	F07	Storeroom Closet		Latch bolt by lever inside and by key outside. Outside lever always rigid. Auxiliary latch deadlocks latch bolt. Inside Lever always free.
M870	F15	Hotel or Motel		Latch bolt by lever inside and by guest key or master key outside. Outside lever always rigid. Deadbolt by thumb turn inside or by emergency key outside. Inside lever will retract both bolts(simultaneously retracts).
M880	F14	Storeroom		Latch bolt operated by lever from either side. Deadbolt by key from either side.
M890	F02 F19	Privacy Bathroom		Latch bolt by lever from either side. Deadbolt by thumb turn inside or by emergency tool outside.
M907	F16	Deadlock		Deadbolt by key either side.
M907	F17	Deadbolt		Deadbolt by key outside or by thumb turn inside.
M907	F18	Deadbolt		Deadbolt by key outside. No inside operation.
M908		Classroom Security		Latch bolt operated by lever from either side unless outside lever is locked by projection of deadbolt . Deadbolt by key from either side. Inside grip simultaneously retracts latch bolt and deadbolt ;outside lever remains locked. Retracting latch bolt by key unlocks outside lever. Auxiliary latch deadlocks latch bolt.



Indicates rigid lever



Indicates interchangeable core available.

LEVER / PLATE MORTISE LOCKSETS

Model No. TCE

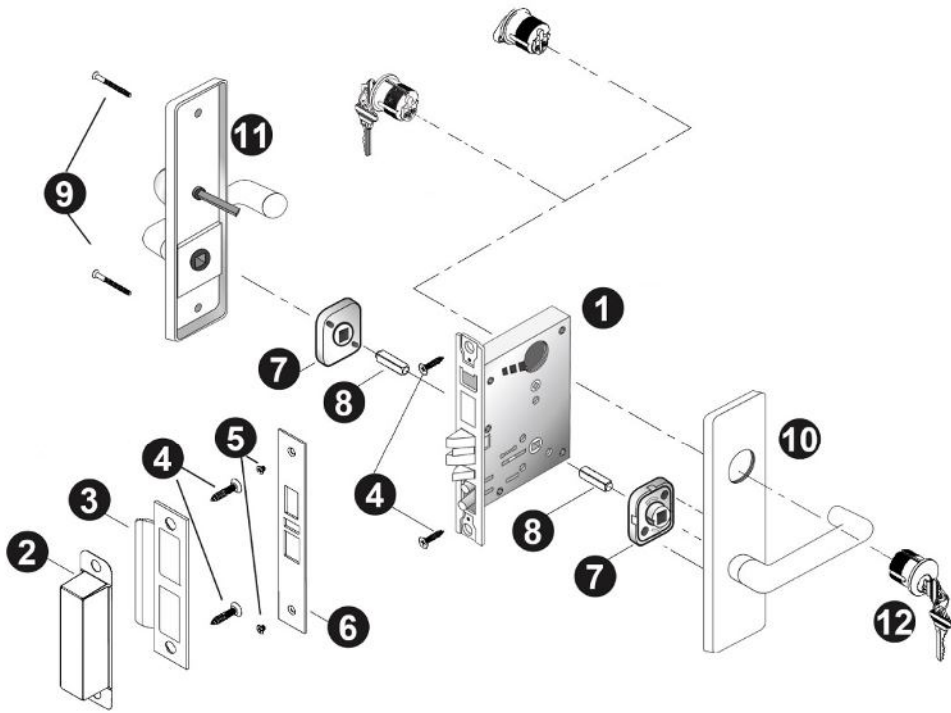

ITEM	QTY	PART DESCRIPTION
1	1	Mortise Lock
2	1	Strike Box
3	1	Strike
4	4	Mounting Screws
5	2	8-32×1/4" FHMS
6	1	Armor Front Face Plate
7	2	Spring Assembly
8	2	Spindle
9	2	Mounting Screws
10	1	Outside Plate/Lever
11	1	Inside Plate/ Lever
12	1	Cylinder
13	-	Inside Cylinder
14	-	Inside Turn Cylinder
15	1	Installation
16		



ST 001



ST 002



ST 003



ST 006



ST 011



ST 012



ST 015



ST 016



ST 017